



Sensor Faucets and Flush Valves

H8-B1-025-MB

0.5 GPF

AC Powered Flush Valve (Urinal)

Description

AC powered, sensor operated, water conserving, closet flush valve for floor mounted or wall hung top spud bowls.

Flush Cycle

- 0.25 GPF
 - * Flush valves may not function with all bowls. Be sure to verify flow requirements with bowl manufacturer.
 - * Flow rate is field adjustable

Specifications

Exposed, Piston Operated, Matte Black Finish, Closet Flush Valve with the following features:

- Standard Brass/All Metal Construction
- Superior, Slow-Closing, Piston Flushing Mechanism
- Standard Manual—Mechanical Override Button
- Adjustable to Left Rough-In (additional part required)
- Operating Pressures: 10-125 PSI
- Standard Self-Cleaning Filtering System
- Superior VSI Silicone Elastomer Piston Seals are Unaffected by Chlorine, Chloramines, and Ammonia
- ADA Compliant—Infrared Sensor Operated for “No Hands” operation
- Self-Diagnostic Electronic System with Manual Reset
- Reliable, Latching Solenoid Valve
- Preset / Adjustable Sensor Distance
- Adjustable Tailpiece
- 3/4" I.P.S. Angle Stop Valve with Vandal Resistant Cap
- High Back Pressure Vacuum Breaker / Flush Tube Connection
- Spud Coupling and Flange for 3/4" Top Spud
- Sweat Solder Adapter with Cover Tube and Wall Flange
- High Copper, Low Zinc Brass Casting for Dezincification Resistance
- 36-hour Sentinel Flush

Electrical Specifications

- Plug-In Power Adapter
Input: 120V AC (60 Hz), Output: 12V DC
- Solenoid Valve and Sensor, 6V DC

Optional Accessories

- HC-010 Multi-Unit Power Adapter (Powers up to 8 flush valves)
- HC-0104 Multi-Unit Power Adapter (Powers up to 4 flush valves)

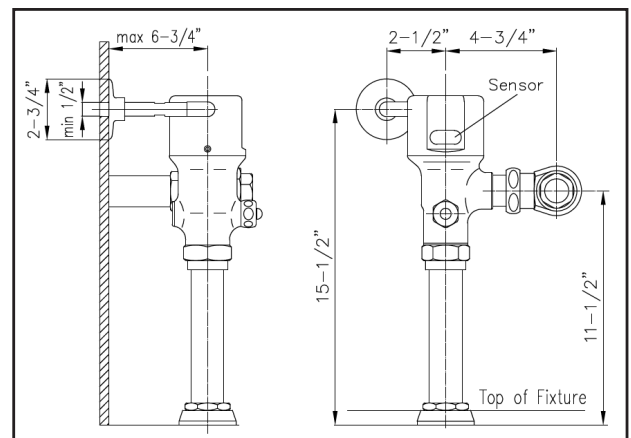

HYDROTEK INTERNATIONAL, INC.
5055 Forsyth Commerce Rd., Ste 124
Orlando, FL 32807
800.922.9883 (Phone)
866.670.5580 (Fax)
www.hydrotekintl.com