



Sensor Faucets and Flush Valves

HB8-B1-05

0.5 GPF

Battery Powered Flush Valve (Urinal)

Description

Battery powered, sensor operated, water conserving, urinal flush valve for floor mounted or wall hung top spud urinals.

Flush Cycle

- 0.5 GPF
 - * Flush valves may not function with all bowls. Be sure to verify flow requirements with bowl manufacturer.
 - * Flow rate is field adjustable

Specifications

Exposed, Piston Operated, Chrome Plated, Closet Flush Valve with the following features:

- Standard Brass/Chrome Plated All Metal Construction
- Superior, Slow-Closing, Piston Flushing Mechanism
- Standard Manual –Mechanical Override Button
- Field Adjustable to Left or Right Rough-In
- Operating Pressures: 10-125 PSI
- Standard Self-Cleaning Filtering System
- Superior VSI Silicone Elastomer Piston Seals are Unaffected by Chlorine, Chloramines, and Ammonia
- ADA Compliant—Infrared Sensor Operated for “No Hands” operation
- Reliable, Latching Solenoid Valve
- Preset / Adjustable Sensor Distance
- Adjustable Tailpiece
- ¾” I.P.S. Angle Stop Valve with Vandal Resistant Cap
- High Back Pressure Vacuum Breaker / Flush Tube Connection
- Spud Coupling and Flange for ¾” Top Spud
- Sweat Solder Adapter with Cover Tube and Wall Flange
- High Copper, Low Zinc Brass Casting for Dezincification Resistance
- 36-hour Sentinel Flush
- (4) AA Alkaline Batteries—Furnished

Electrical Specifications

- Battery: (4) AA Alkaline Batteries
- Solenoid Valve and Sensor, 6V DC
- Battery Service Life: 400,000 flushes, up to 4 years



Compliances & Certifications



- ADA Compliant
- ASSE 1037/ASME A112.1037/CSA B125.37-2015
- IPC, IRC, and UPC Compliant
- WaterSense Listed - WaterSense compliant when used with a 0.5 GPF WaterSense Fixture

Special Finishes

- Brushed Nickel (HB8CBN-B1-05)
- Polished Brass (HB8CPB-B1-05)
- Matte Black (HB8CMB-B1-05)
- Additional finishes available upon request



The information contained within this document subject to change without notice

5055 Forsyth Commerce Rd Ste 124, Orlando, FL 32807
Phone: 800.922.9883 | Fax: 866.670.5580 | hydrotekintl.com



Sensor Faucets and Flush Valves

HB8-B1-05

0.5 GPF

Battery Powered Flush Valve (Urinal)

Rough-in Dimensions

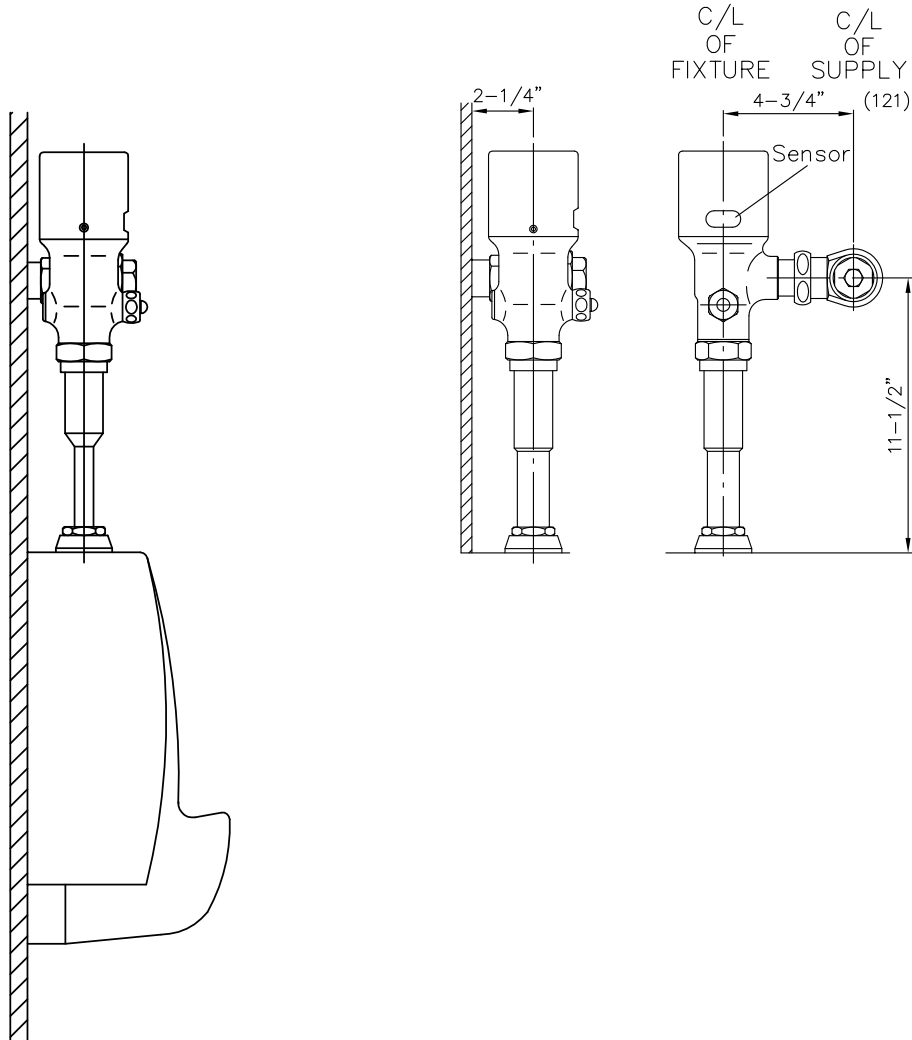

HB8-B1-05 Urinal
3/4" IPS Angle Stop
3/4" Top Spud

The information contained within this document subject to change without notice

5055 Forsyth Commerce Rd Ste 124, Orlando, FL 32807
Phone: 800.922.9883 | Fax: 866.670.5580 | hydrotekintl.com