



ISO 9001 Certified



OPERATION & MAINTENANCE MANUAL

4000C Series Faucet

www.hydrotekintl.com

5055 Forsyth Commerce Rd, Ste 124, Orlando, FL 32807
Phone (800) 922-9883 | Fax (866) 670-5580



ISO 9001 Certified

4000C Series

U.S. Patent 6192530B1, 4741363

AC or Battery Powered Sensor Operated Faucet

The 4000C Series faucet is a single-hole deck mounted, piston operated sensory faucet that provides a vandal resistant, no touch lavatory solution with hot/cold mixing and manual on/off that promotes better hygiene and energy savings.

- **ADA Compliant.** Meets all barrier free codes
- Conserves water and energy
- Easily installed in new or retrofit applications
- Competitively priced for today's commercial market
- Promotes cleanliness & hygiene
- Proven Hydrotek craftsmanship and reliability

Available in:

AC Powered Models

- ✓ Low Lead, AC Powered (H-4000C-LR)
- ✓ Low Lead, AC Powered Scrub Sink (H-4000C-SD-LR)
- ✓ Low Lead, AC Powered with DC Backup (H-4000C-LRDC)
- ✓ Low Lead, AC Powered with DC Backup Scrub Sink (H-4000C-LRDC)

Battery Powered Models

- ✓ Low Lead, Battery Powered (HB-4000C-LR)
- ✓ Low Lead, Battery Powered Scrub Sink Version (HB-4000C-SD-LR)



Features:

- **ACCU-SENSE** adjustable sensor eyes.
- Chrome plated, solid brass construction.
- Wall mountable, waterproof control box with armored, vandal resistant control and power cables.
- Preset/adjustable sensor range of 6" - 30" for various installation requirements.
- Standard automatic time-out feature. Preset at 30 seconds, but adjustable to 10, 30, or 60 seconds. Prevents accidental sink overflow.
- Shut-off delay is adjustable from 1 (preset) to 8 seconds.
- Solid brass body with single hole deck mounting. Optional 4" or 8" cover plate for 3 point anchoring.
- Includes in-line filter with clean-out trap to reduce maintenance costs.
- All parts are field-replaceable to ensure quick and easy repair.
- Same faucet-field switchable to AC or battery powered.
- AC with DC backup models automatically switch to batteries during a power outage.
- Manual override provides continuous water flow for special applications or in case of failure.
- Manual controlled temperature adjustment.
- Slow closing, piston-operated solenoid valve provides reliable and smooth operation without water hammer.
- Superior VSI silicone elastomer piston seals are unaffected by chlorine, chloramines, or ammonia.
- Standard 2.0 GPM Laminar flow control.
- Control module allows a unique self-check of all electrical components.

Hydrotek Automatic Faucets

4000C Series

Deck Mounted / Mixing / Manual On & Off with Temperature Adjust

Meets ANSI/ASME A112.18.1 M-1989

Operation:

1. A continuous, invisible beam is emitted from the sensor.
2. The faucet is activated by placing hands under the spout within the effective range of the beam. Water starts to flow immediately for as long as the user's hands remain in the sensor range.
3. When hands are removed, the water flow stops. The sensor will automatically reset and be ready for the next user.
4. In the battery powered version, a flashing red light will indicate a low battery condition.
5. Use the faucet handle for temperature adjustment and manual on/off.

Specifications:

Faucet Construction:

- Solid brass, chrome plated

Control Circuit:

- Solid state, AC or battery, switchable

Auto. Time-out:

- Preset at 20 seconds and adjustable

to 10, 30, or 60 seconds

Line Purge (request only):

- 2 minute run every 12 hours or 24 hours

Scrub Mode Delay (request only):

- 60, 120, 180 seconds

Sensor Range:

- Preset and adjustable

Shut-off Delay:

- Presets and adjustable from 1-8 seconds

Control Cable:

- Armored, vandal resistant

Solenoid Valve:

- 6V DC, normally closed

- Wattage: 0.4W (idle), 5W (in use)

- Operating Pressure: 5 psi to 125 psi

- 2.0 GPM, Laminar Flow Control

- 2.5 GPM Rose Spray for scrub sink

Flow Control:

Mode

Power Adapter

Standard Plug-in:

(UL/CSA)

- Input AC 120V 60 Hz or 220V

- Output DC 12V, 0.8A/Class 2

Power Cable:

- Armored, vandal resistant

Optional Multi-Unit Adapter:

- Serves up to 8 faucets

(UL/CSA)

- Input AC 120V, Output DC 12V, 3A

Battery Mode

Battery Powered Models:

- (4) AA Alkaline Batteries

Battery Service Life:

- 400,000 on/off cycles, up to 4 years

Package Includes:

- (1) Faucet with electronic sensor
- (1) Control box
- (1) 12V DC plug-in power adaptor (H-4000C, -DC, -LR and -LRDC only)
- (1) In-line filter with clean-out trap
- (1) Flex, S.S. supply tube, 3/8"
- (1) 6" Gooseneck Spout
- (1) Mounting hardware
- (1) 2.0 GPM Flow Control
- (4) AA Alkaline batteries (HB-4000C, -DC, -LR, -LRDC only)
- (1) Battery holder (HB-4000C, -DC, -LR, -LRDC only)

Dimensions:

Base Width (Outside Measurement)	2-1/2"
Base Depth	2"
Faucet Height (Aerator to Base)	5-1/4"
Faucet Height Overall	6-3/8"
Depth (Center of Aerator to Center of Faucet Base)	5-1/8"
Mounting Bolt Length	2-1/2"
Mounting Bolt Pattern	Single-hole mount

Optional Variations and Accessories

- 1.5 GPM Soft-Flow Aerator; 0.35, 0.5, 2.2 GPM Laminar Flow
- 4" or 8" Centerset Cover Plate
- HC-010 Multi-Unit Voltage Adapter (AC Powered Only) - 8 units
- HC-0104 Multi-Unit Voltage Adapter (AC Powered Only) - 4 units
- HBL-04 Thermostatic Mixing Valve with Checks

H-4000C (AC Powered)

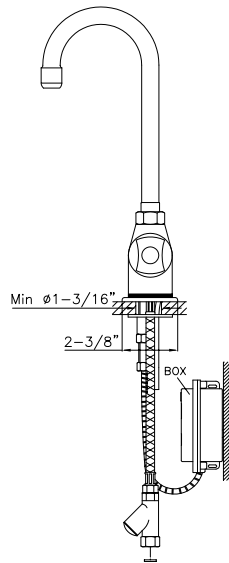
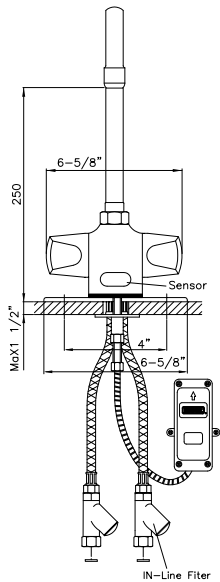

HB-4000C (Battery Powered)

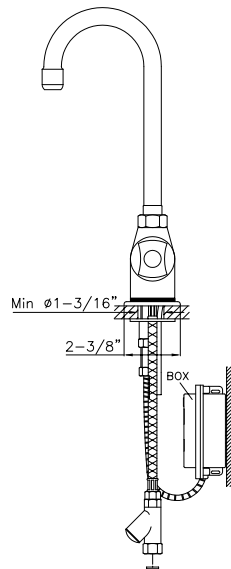
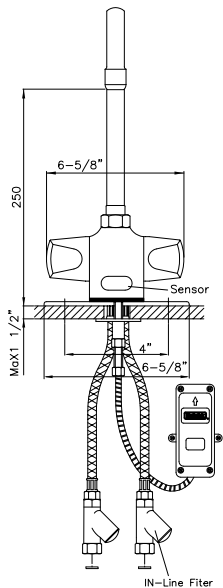

HYDROTEK INTERNATIONAL, INC.

5055 Forsyth Commerce Rd., Ste 124

Orlando, FL 32807

800.922.9883 (Phone)

866.670.5580 (Fax)

www.hydrotekintl.com



4000C Series

DC Powered Sensor Operated Mixing Faucet

Installation Instructions

1. Prior to installation, thoroughly flush all water lines and replace stop washers, if required.
2. To ensure proper operation, "DRY TEST" the faucet by plugging the **Control Cable (10)** into the matching connector on the PC board inside of the **Control Box (11)**.
 - a. **AC Powered:** Connect the power adapter to the **Control Module (12)** inside of the **Control Box (11)**, then plug the Power Adapter into a 120 V AC wall outlet. Place your hand in front of the sensor eye and listen for a clicking sound. If there is no clicking sound, call the factory.
 - b. **Battery Powered:** Properly install new batteries into the battery holder and ensure the battery holder is connected to the PC board. Place your hand in front of the sensor eye and listen for a clicking sound. If there is no clicking sound, call the factory.
3. After a successful "DRY TEST", unplug the **Control Cable (10)** and power adapter or battery holder from the PC board.
4. Attach the hot and cold water **Supply Tubes (7)** by screwing the threaded ends into the bottom of the faucet body.

NO TEFLON TAPE, NO PIPE DOPE
5. [OPTIONAL] affix the cover plate to the bottom of the faucet and apply plumbers putty to the bottom of the faucet and the cover plate.
6. Position faucet by lowering the flexible **Supply Tubes (7)** and **Control Cable (10)** through the deck hole. Secure the faucet to the sink deck using the **Mounting Washer (5)** and **Mounting Nut (6)**.
7. Considering the length of the **Control Cable (10)**, drill two holes into the wall and insert the mounting anchors into those holes. Position the control box so that the **Control Cable (10)** enters the box from the bottom. Attach the **Control Box (11)** to the wall by aligning the box mounting holes with mounting anchors and using the the anchor screws.
8. Attach the **Filters/Check Valves (8)** to the stop valves using the **Nylon Washers (9)** inserted into the filter inlet. Attach **Supply Tubes (7)** to filter/check valves compression fittings. Left is the HOT supply tube and right is the COLD supply tube.

NO TEFLON TAPE, NO PIPE DOPE
9. Mount **Gooseneck Spout (2)** onto the fauet using the **Lock Nut (3)**. Open stop valves and check for leaks. Test the faucet using the manual control handle on the right side of the faucet. This handle can also be used to set the water temperature.
10. Connect the electrical cables as described in step 2. Control and power cables must be seated in the control box properly to maintain waterproof seal. Reinstall the control box cover.
11. Test faucet by placing hands under spout. Water should begin to flow. Water flow should stop when hands are removed. If the faucet does not function properly, refer to the troubleshooting guide.
12. Sensor sensitivity is preset at the factory. If you need to alter this setting, please call Hydrotek 1-800-922-9883.

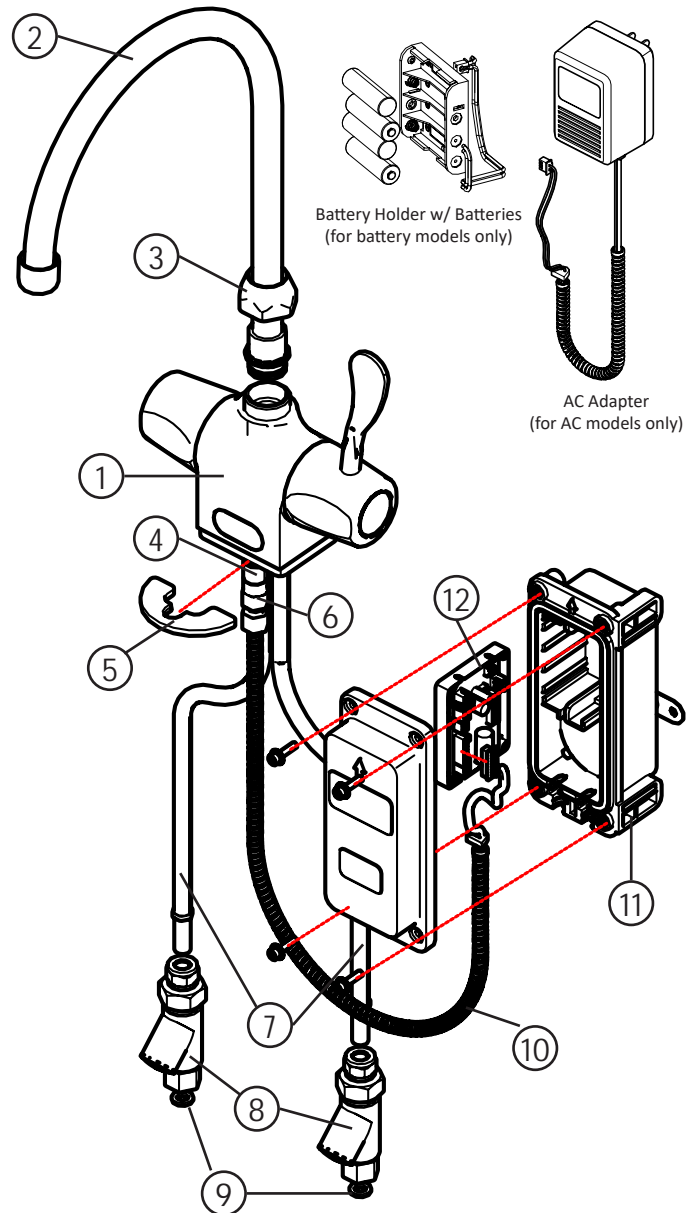

Parts:

1. Faucet Body	7. Supply Tube (2)
2. Gooseneck Spout	8. Filter/Check Valve (2)
3. Spout Lock Nut	9. Nylon Washer
4. Mounting Bolt	10. Control Cable
5. Mounting Washer	11. Control Box
6. Mounting Nut	12. Control Module

HYDROTEK INTERNATIONAL, INC.
 5055 Forsyth Commerce Rd., Ste 124
 Orlando, FL 32807
 800.922.9883 (Phone)
 866.670.5580 (Fax)
www.hydrotekintl.com



4000C Series

Sensor Operated Mixing Faucet Troubleshooting Guide

Normal Operation: When power is connected, the faucet will immediately perform diagnostic function. You will hear a clicking sound and see lights flash. When the user's hands are placed under the spout, the light will flash once and water will start to flow. Water flow will stop when hands are removed. The red indicator light will flash when the batteries are low.

Turn the manual handle clockwise to increase temperature and counter-clockwise to decrease.

Problem	Possible Cause	To Diagnose	Remedy
Faucet will not turn on:	Water not turned on	Check water supply	Turn water on
	Power supply failure	No light, no clicking: • Check batteries • Check power adapter	Reinstall or replace batteries/ Replace power adapter
	Low battery	Light continues to flash	Replace batteries
	Electronic PCB / Sensor is defective	No light, no clicking: • Reinsert batteries • Reattach power adapter	Replace electronic PCB
	Solenoid valve is clogged	Solenoid is clicking but no water is coming out	Clean solenoid
	In-line filter is clogged	Open clean-out trap and check filter screen	Clean or replace filter screen
	Solenoid coil is defective	Insert new batteries or reattach power adapter. Light blinks but no solenoid is clicking	Replace solenoid coil
	Flow control is clogged	Open flow control device and check	Celan the flow control device
Faucet will not shut off, has low glow, or drips:	The solenoid valve is normally closed. Turn off water and activate the faucet. If there is a clicking sound, the solenoid valve is dirty. If there is no clicking sound, then check the solenoid valve. If the faucet is dripping, clean the solenoid valve.		

IMPORTANT: Periodic maintenance is required for smooth and trouble-free operation of this faucet.

For service and inquiry about available repair kits, please call Hydrotek Technical Support at (800) 922-9883.

Care and Cleaning Instructions:

- **WARNING!** Using abrasive or chemical cleaners **will** damage the chrome or decorative finishes.
- Use only soap and water to clean the finish, then wipe dry with a clean cloth.
- If chemical cleaners are used for other parts of the lavatory, ensure that the faucet is protected from potential contact from those cleaners.

4000C Series

Sensor Operated Mixing Faucet

Solenoid Valve Repair Kit Installation

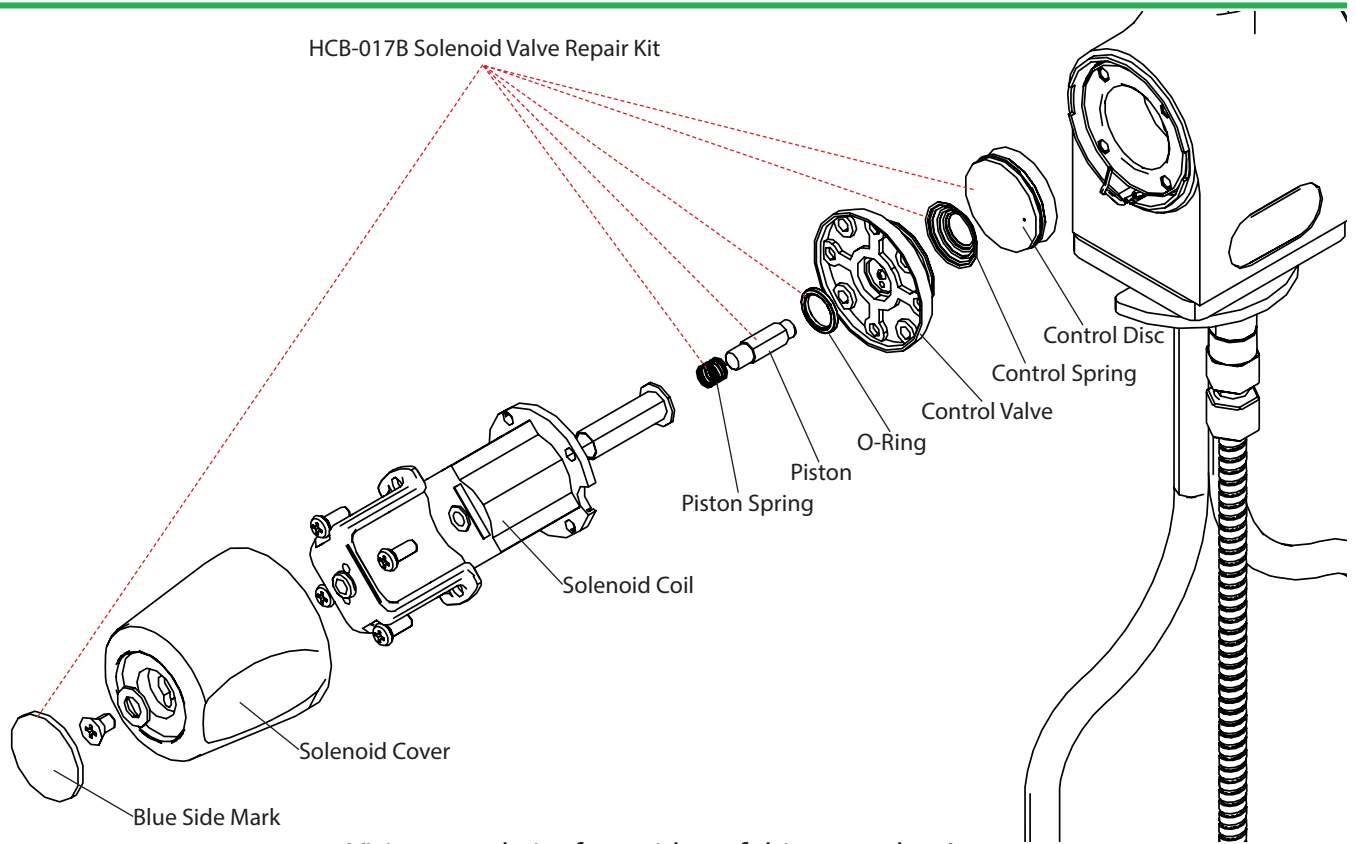

Visit our website for a video of this procedure!
www.hydrotekintl.com

1. Disconnect power by unplugging the power adapter (for AC powered models) or unplugging the battery pack inside the control box.
2. Turn off the water at the angle stop valve or the main supply.
3. Turn the adjustment handle (right side of the faucet) into manual override mode to purge the rest of the water from the faucet.
4. Pry the Blue Side Mark off of the Solenoid Cover.
5. Remove the Solenoid Cover by removing the phillips head screw holding it in place.
6. Remove the screws holding the Solenoid Coil and carefully separate the coil from the faucet body.
7. Gently pry the Control Valve from faucet and remove the Control Spring and Control Disc. The Control Disc can be easily removed by opening the water supply slowly until the Control Disc is pushed out of the faucet.
8. Inspect the Valve Seat for debris and clean if necessary with fine grain steel wool.
9. Replace the Piston and Piston Spring within the Solenoid Coil.
10. Replace the O-Ring, Control Spring, and Control Disc and reassemble according to the diagram above.
11. Install the Solenoid Coil, Solenoid Cover and Blue Side Mark according to the diagram above.
12. Turn on the water supply and check for leaks. Test the manual override function by turning the adjustment handle to manual override mode.
13. Reconnect the power and push the reset button on the Control Module (circuit board). Make sure the adjustment handle is in AUTO mode and test the sensor function of the faucet.

**Solenoid Valve maintenance recommended every 4 years.*

4000C Series

Sensor Operated Mixing Faucet Control Module Settings

Settings Control Dipswitches

Reset Button

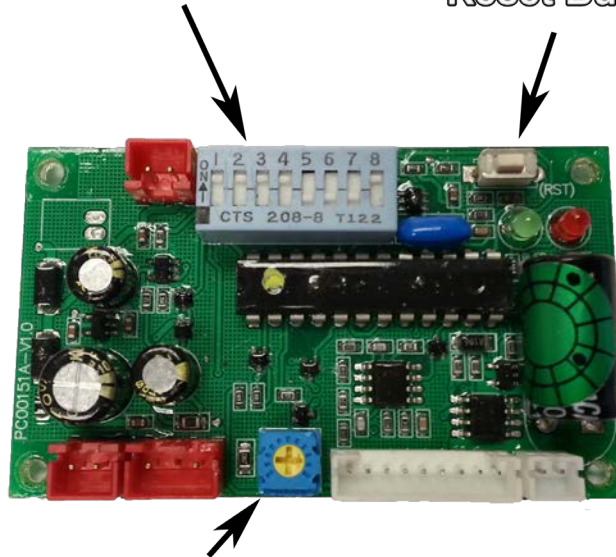

Sensor Length Adjuster

Shut Off Time Delay (After hands are removed)

Sw1	Sw2	Sw3	Delay
On	On	On	1 Sec
On	On	Off	2 Sec
On	Off	On	3 Sec
On	Off	Off	4 Sec
Off	On	On	5 Sec
Off	On	Off	6 Sec
Off	Off	On	7 Sec
Off	Off	Off	8 Sec

Factory Preset

■ = Switch Position

1	2	3	4	5	6	7	8

Sensor Distance

Sw6	Mode	Distance
On	Std	4" - 12"
Off	Enhanced	10" - 12"

To increase distance, turn adjuster CLOCKWISE
To decrease distance, turn adjuster COUNTER-CLOCKWISE

Automatic Time Off (maximum run time after activation)

Sw4	Sw5	Time Off
On	On	OFF
On	Off	15 Sec
Off	On	30 Sec
Off	Off	60 Sec

Faucet Switch - DO NOT TOUCH

Sw7	Sw8	Mode
On	Off	Auto Faucet

IMPORTANT: Always push the Reset Button after any adjustments

4000C Series

Sensor Operated Mixing Faucet

Assembly Parts

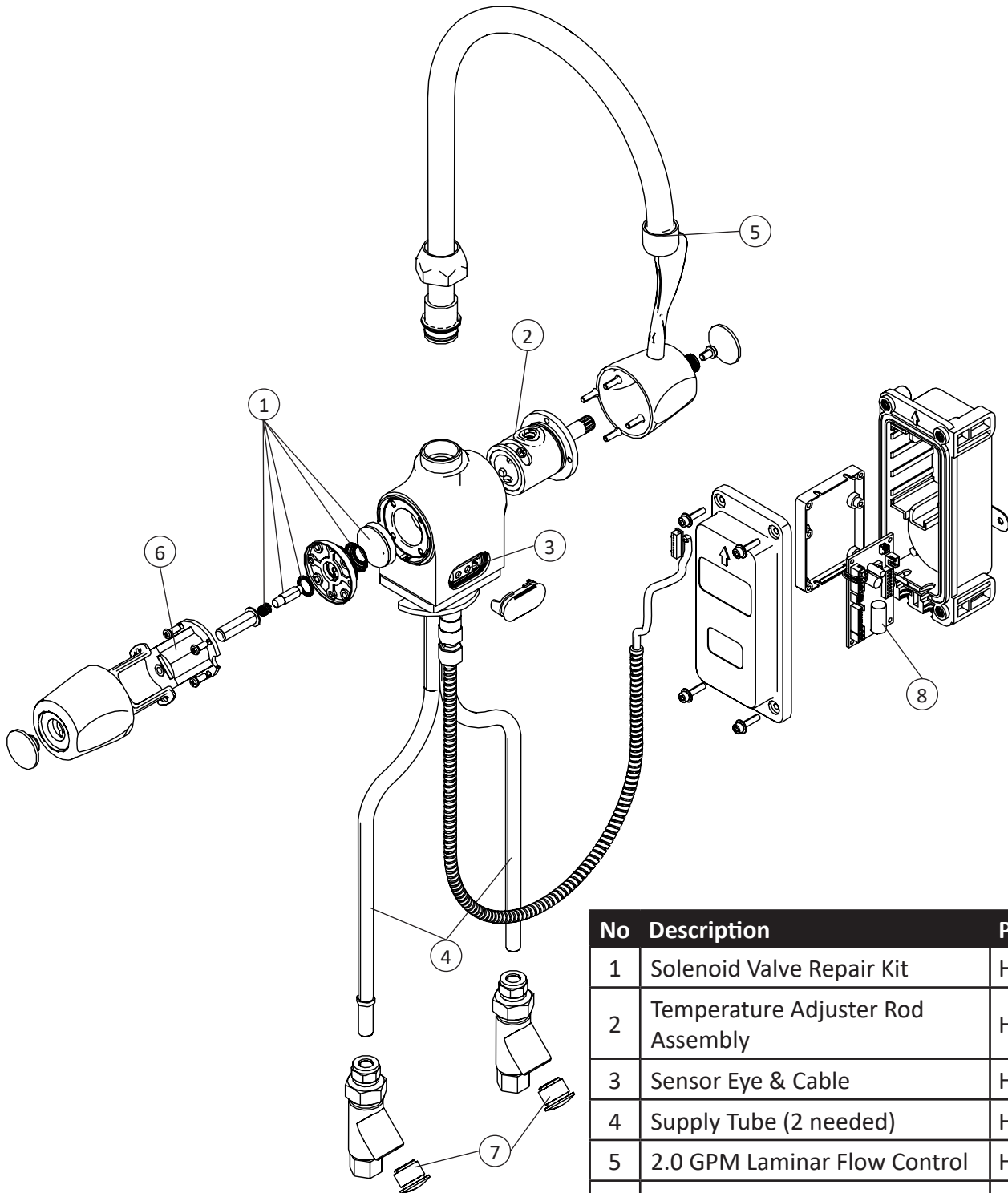

No	Description	Part Number
1	Solenoid Valve Repair Kit	HCB-017B
2	Temperature Adjuster Rod Assembly	HC-027A
3	Sensor Eye & Cable	HCC-032
4	Supply Tube (2 needed)	HC-025C
5	2.0 GPM Laminar Flow Control	HB-003CF
6	Solenoid Coil	HCC-019
7	Filter Screen (2 needed)	HC-020
8	PCB Module	HCC-011B

Please visit our website, www.hydrotekintl.com, for our most current Products Pricing Sheet.